

01 /
new collection

MAGNETICA

Pareti e accessori con calamita
per un nuovo stile

Architettura per il Bagno

ARCOM

MAGNETICA

Spessore 1,5 mm



Magnum 02

pagina 6-7

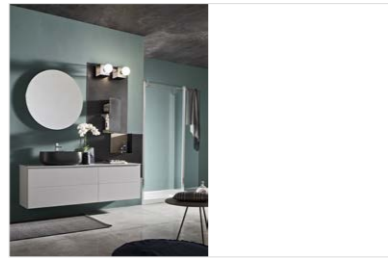

Magnum 03

pagina 10



Magnum 01

pagina 12-13



Magnum 04

pagina 16-17



Magnum 05

pagina 20-21

Spessore 28 mm



Magnum 06

pagina 24-25



Magnum 07

pagina 28-29

NM

The magnetic essence of design:
walls and accessories with magnetic effects
for best personalising the space.

MAGNETICA

L'ANIMA MAGNETICA
DEL DESIGN:
PARETI E ACCESSORI
CON EFFETTO
CALAMITA PER
PERSONALIZZARE
AL MASSIMO LO SPAZIO.

QUATTRO SEMPLICI STEP PER CREARE LA TUA PARETE ATTREZZATA IN PIENA LIBERTÀ E IN MODO FACILE.

Four simple steps to create your
accessorised walls conveniently and
in full freedom.

- 1** Crea la tua parete magnetica combinando dimensioni, spessori e forme dei pannelli.

Create your magnetic wall by combining panels offered in a selection of shapes, thickness and sizes.

- 2** Scegli e personalizza gli accessori con colori e finiture.

Choose and personalise the accessories with various colours and finishes.

- 3** Posiziona sulla parete gli accessori come preferisci e come più ti piace.

Arrange the accessories on the wall as you like and as it best suits your taste.

- 4** Sposta gli accessori sulla parete ogni volta che vuoi.

Reposition the accessories on the wall any time.

STILE MAGNETICO

Magnetic style



COLORE ANTRACITE
Anthracite colour

INSERTO ACCESSORI
Accessories insert

L'inserto è personalizzabile in
essenza o laccato opaco
The insert is customisable in
wood finish or matt lacquer

ANTI-IMPRONTA
Anti-fingerprint

FINITURE

I pannelli magnetici sono disponibili con finitura
metallica in colore antracite.
Il trattamento anti-impronta mantiene le superfici
pulite e le protegge dai graffi.
Negli accessori la finitura in metallo può essere
abbinata ad inserti in essenza o in laccato opaco.

Finish

The magnetic panels are available in metallic finish
or in anthracite colour.
The anti-fingerprint treatment keeps surfaces clean
and protects them from scratches.
For accessories, the metal finish can be combined
with inserts in wood finish or matt lacquer.



BOISERIE MAGNETICA
Magnetic wall panelling

ACCESSORI CON CALAMITA
Magnetic accessories

vedi pagina 32
see page 32

DIMENSIONI PANNELLO

Larghezza - Width

1000 mm

Altezza - Height

250-500-700 mm

BOISERIE MAGNETICA

**Infinite composizioni
con la boiserie magnetica**

MAGNETIC WALL PANELLING
Endless opportunities for magnetic wall panelling compositions

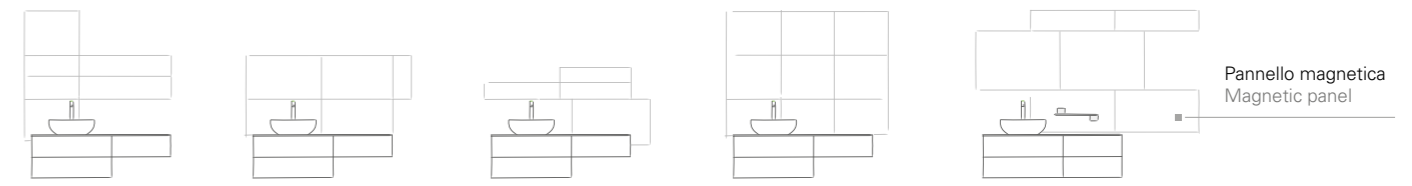

Pannello magnetica
Magnetic panel



PANNELLO 1,5 mm

Disponibile in orizzontale,
verticale o a L

1.5 mm PANEL
Available in horizontal, vertical
or L-shaped versions

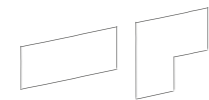

SPESSORE *LIGHT* 1,5 mm

I pannelli dallo spessore sottile sono disponibili in
formato rettangolare, da installare con orientamento
orizzontale o verticale, e con forma a L, orientabile
verso destra o sinistra. Gli elementi possono essere
combinati a piacere.

The thin panels are available in rectangular shape, to
be installed horizontally or vertically and in L-shape,
adjustable to the left or to the right. The elements can
be combined as desired.



PANNELLO 28 mm

Disponibile in orizzontale e verticale
Accostabile alle piastrelle

28 mm PANEL
Available in horizontal and
vertical versions
Can be coordinated with the tiling



BOLD 28 mm

Lo spessore più forte e marcato può essere abbinato ai
rivestimenti in ceramica per creare una continuità senza
bordi. I pannelli sono disponibili in formato rettangolare
e possono essere disposti in orizzontale o in verticale.

The more pronounced thickness can be combined with
ceramic tiling for creating continuity without edges.
The panels are available in rectangular format and can
be arranged horizontally or vertically.

CREA CON GLI OGGETTI

**Accessori con calamita da attaccare
alla parete magnetica**

CREATING WITH OBJECTS
Magnetic accessories for use with the magnetic wall

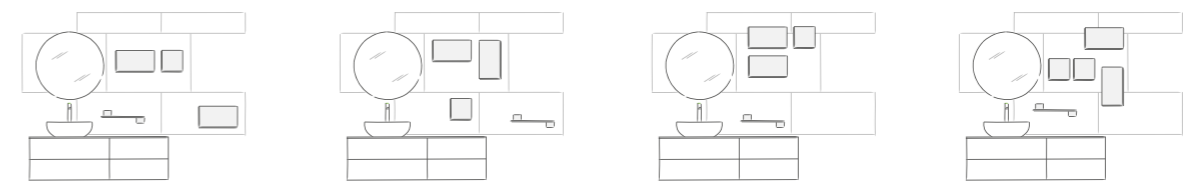

MAGNETICA LIGHT

spessore 1,5 mm



Una soluzione leggera
"a filo parete" che permette
di creare spazi sempre diversi,
assecondando i gusti e le
esigenze del momento.

A light solution "flush with the
wall", for the endless possibility
of new spaces based on
current needs and tastes.





Esempio di spostamento
Da A a B e viceversa con un solo gesto

Example of reconfiguration
From A to B and vice versa, with a single gesture



In alto, in basso, a destra o a sinistra: spostare gli accessori non è mai stato così semplice e veloce.

Up, down, left or right: repositioning accessories has never been so quick and easy.



Soluzione A



Soluzione B

ATTRAZIONE NATURALE TRA PARETE, MENSOLE E ACCESSORI

A natural attraction between walls,
shelves and accessories



SOLUZIONE COMPATTA

Compact solution



Mensole verticali progettate per personalizzare

Vertical shelves designed to customise

Le mensole con calamita si applicano direttamente sulla parete magnetica e danno vita a composizioni libere e facili da creare, anche in piccoli spazi e con pochi elementi.

Shelves with magnets are applied directly on a magnetic wall, giving life to free compositions that are easy to create, even in small spaces and with the use of few elements.

PARETE ATTREZZATA

Accessorised walls

Le mensole e gli accessori si attaccano-staccano spostandosi liberamente sulla parete magnetica, per chi predilige il movimento alla staticità.

The shelves and the accessories are easily attached and detached and can be freely repositioned on the magnetic wall, for those who prefer movement over stillness.



COLORI E FINITURE PER CALAMITARE L'ATTENZIONE

Colours and finishes for a magnetic focus

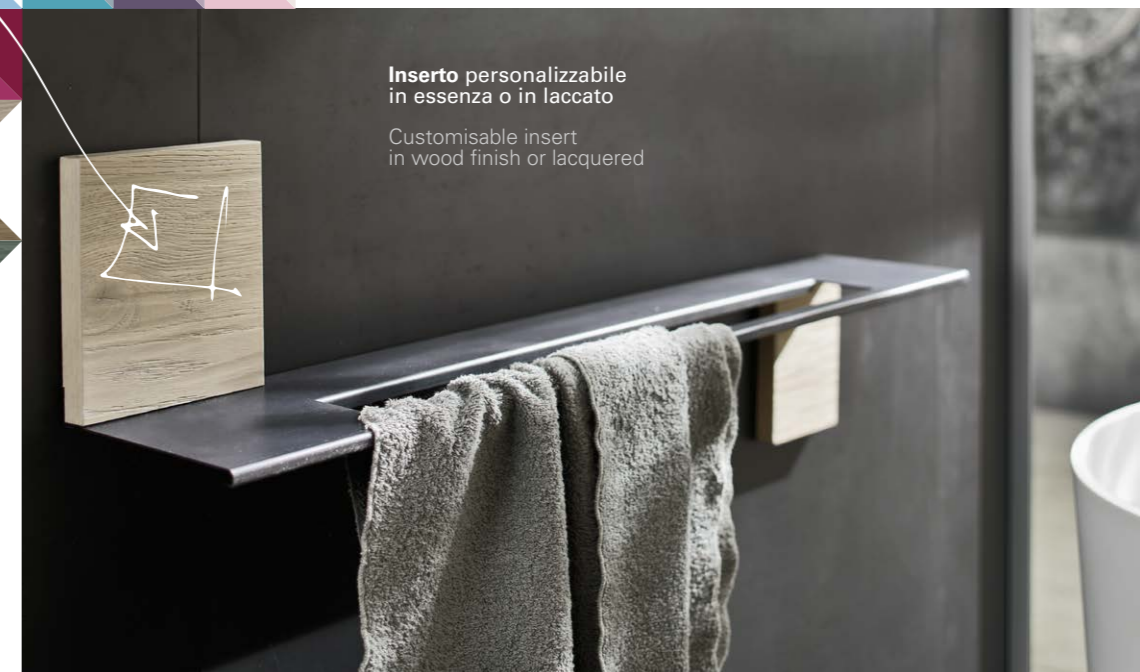

**Inserto personalizzabile
in essenza o in laccato**

Customisable insert
in wood finish or lacquered

Un'ampia palette di colori opachi e di finiture in essenza personalizza gli accessori che, oltre a muoversi sulla parete magnetica, esprimono il carattere dello spazio.

A wide palette of opaque colours and wood finishes customise the accessories that, in addition to moving freely on the magnetic wall, capture and express the character of the space.

PARETI MAGNETICHE E SUPERFICI DECORATE: IL NUOVO LOOK DELL'ARREDO BAGNO

Magnetic walls and decorated surfaces: the new look of bathroom furniture





Boiserie magnetica abbinata alle grafiche decorative

Magnetic wall panelling combined with decorative graphic elements

Calamite e decori personalizzano l'ambiente bagno con stile. Via libera alla creatività e alla libertà compositiva.

Magnets and décor customise your bathroom space with style. Creativity and freedom of composition.





SEGNI PARTICOLARI: ORIGINALE E MAGNETICA

Distinguishing features: original and magnetic

In orizzontale o in verticale, a tutta parete o a fasce:
la boiserie magnetica è una soluzione pratica e innovativa
per reinterpretare lo spazio ogni giorno.

Horizontal or vertical placement, full wall or in sections:
magnetic panelling offers a practical and innovative
solution for reinterpreting spaces on a daily basis.



MAGNETICA

BOLD

spessore 28 mm

La boiserie magnetica dallo spessore più forte è l'ideale per essere abbinata ai rivestimenti in ceramica o semplicemente per chi preferisce i bordi marcati.

The magnetic wall panelling characterised by a more pronounced thickness is ideal for being combined with ceramic tiling or simply for those who prefer pronounced edges.

DALLE LUCI AGLI SPECCHI: L'EFFETTO MAGNETICO CHE ATTIRA GLI OGGETTI

From lights to mirrors:
the magnetic effect that attracts objects



Le lastre magnetiche appliche sulla parete in orizzontale o in verticale attraggono a sé mensole di varie finiture e colori o altri accessori con calamita.

The magnetic panels affixed to the wall horizontally or vertically rely on the use of magnets to attract shelves offered in various shapes and colours or other accessories.



LIBERI DI
 CREARE,
 COMPORRE E
 CAMBIARE
 IL PROPRIO
 SPAZIO

Free to create, compose and
 change your space



Accessori con calamita progettati per cambiare

Magnetic accessories designed for continuous change

Porta oggetti, porta asciugamani, mensole, cubotti, specchi e faretti: una vasta gamma di accessori con calamita da attaccare, togliere e spostare.

Storage for objects, towel racks, shelves, cubes, mirrors and spotlights: a wide range of magnetic accessories to attach, detach and reposition.



LA FORZA
MAGNETICA
E ATTRATTIVA
DEL DESIGN

Magnetic force and the appeal of design

Accessori riposizionabili

Repositionable accessories



PORTA ASCIUGAMANO

Un accessorio indispensabile, personalizzabile con inserti in essenza o in laccato opaco.

TOWEL HOLDER

An indispensable accessory, customisable with inserts in wood finish or matt lacquer.

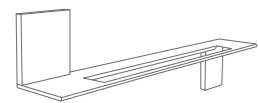

L. 800 x P. 150 x H. 250 mm

Finitura: Metallo
Inserti: Essenza / Laccato opaco
Finish: Metal
Inserts: Wood finishes / Matt lacquers



PORTA SPAZZOLINO

Un accessorio pratico e comodo che arreda la parete. La finitura in metallo può essere abbinata a inserti in essenza o in laccato opaco.

TOOTHBRUSH HOLDER

A practical and convenient accessory that decorates the wall. The metal finish can be combined with inserts in wood finishes or matt lacquer.

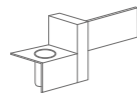

L. 440 x P. 170 x H. 200 mm

Finitura: Metallo
Inserti: Essenza / Laccato opaco
Finish: Metal
Inserts: Wood finishes / Matt lacquers



PORTA ASCIUGACAPELLI

Un accessorio utile per riporre gli oggetti da tenere a portata di mano. L'inserto può essere personalizzato in essenza o in laccato opaco.

HAIR DRYER HOLDER

A convenient accessory for storing objects and keeping everything close at hand. The insert can be personalised in wood finishes or matt lacquers.

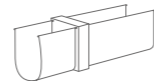

L. 440 x P. 180 x H. 200 mm

Finitura: Metallo
Inserti: Essenza / Laccato opaco
Finish: Metal
Inserts: Wood finishes / Matt lacquers



MENSOLA

Un comodo ripiano per una parete ordinata. Finitura metallo e un fondo da personalizzare in essenza o colorare in laccato opaco.

MENSOLA

A convenient shelf for a well-organised wall. Metal finish and a background that can be customised in wood finishes or coloured in matt lacquers.

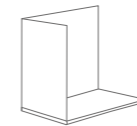

L. 300 x P. 150 x H. 300 mm

Finitura: Metallo
Inserti: Essenza / Laccato opaco
Finish: Metal
Inserts: Wood finishes / Matt lacquers



MENSOLA ORIZZONTALE

Un elemento salvaspazio da coordinare agli altri accessori. Finitura metallo, inserto personalizzabile e la praticità di tenere tutto in ordine.

HORIZONTAL SHELF

A space-saving element to coordinate with the other accessories. Metal finish, customisable insert and the convenience of keeping everything in order.

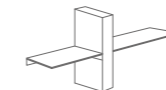

L. 440 x P. 170 x H. 200 mm

Finitura: Metallo
Inserti: Essenza / Laccato opaco
Finish: Metal
Inserts: Wood finishes / Matt lacquers

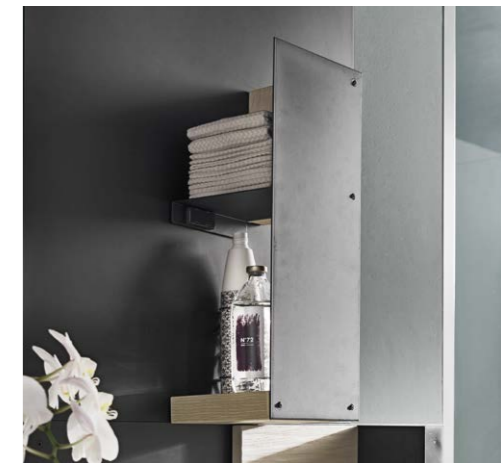

MENSOLA VERTICALE

Per tenere gli oggetti a portata di mano ma meno in vista: la mensola è dotata di un frontale in finitura metallo ed è aperta solamente sui lati.

VERTICAL SHELF

For keeping objects close at hand but less in view: the shelf is equipped with a front in metal finish and is open only on the sides.

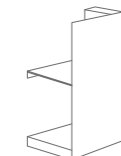

L. 200 x P. 180 x H. 465 mm

Finitura: Metallo
Inserti: Essenza / Laccato opaco
Finish: Metal
Inserts: Wood finishes / Matt lacquers

Accessori riposizionabili

Repositionable accessories



CUBOTTI

Veri elementi di design perfetti per creare originali composizioni sulla parete. Disponibili in un'ampia gamma di colori con finitura in laccato opaco.

CUBOTTI

True design elements perfect for creating original compositions on the wall. Available in a wide range of colours with matt lacquer finishes.

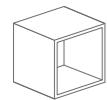

L. 250-350-500-700 x P. 250 x H. 208 mm

Finitura: Laccato opaco
Finish: Matt lacquer



PORTA ROTOLO

Un accessorio che alla funzionalità unisce un design essenziale, in linea con gli altri elementi e la parete magnetica su cui può essere applicato.

TOILET ROLL HOLDER

An accessory that cleverly combines functionality and design, in line with the other elements and with the magnetic wall on which it can be applied.



L. 150 x P. 150 x H. 200 mm

Finitura: Metallo
Inserti: Essenza / Laccato opaco
Finish: Metal
Inserts: Wood finishes / Matt lacquers



SPECCHIO TONDO

Uno specchio tutto-vetro, senza cornice, dalle forme rotonde e dalle linee pulite da posizionare e spostare liberamente sulla parete.

ROUND MIRROR

An all-glass frameless mirror featuring a round shape and clean lines, to be freely positioned and moved on the wall.

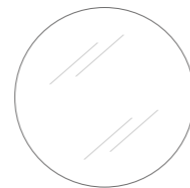

Ø 610 x Ø 800 mm



SPECCHIO VERTICALE

Disponibile in varie dimensioni per essere attaccato sopra il lavabo o a lato. Il lato magnetico permette una continua libertà di spostamento.

VERTICAL MIRROR

Available in various sizes, to be positioned over the wash basin or on the side. The magnetic side allows for continuous freedom of movement.



Disponibile in varie dimensioni
Available in various sizes



FARETTO

Le luci possono essere posizionate al lato dello specchio o in altri punti della parete magnetica. In ogni momento si spostano e riposizionano.

FARETTO

Lights can be positioned beside mirrors or on other parts of the magnetic wall. They can easily be moved and repositioned at any time.



L. 150 x P. 153 x H. 153 mm

Finitura: Metallo
Inserti: Essenza / Laccato opaco
Finish: Metal
Inserts: Wood finishes / Matt lacquers

Composizioni

Compositions

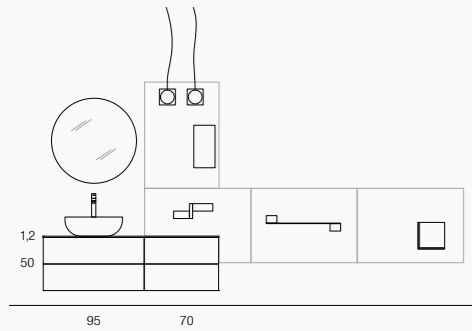

Magnum_02 (pag. 6-7)
L.166 x P.38 cm + sporgenza lastre
Pollock laccato Perla opaco
Top laccato Perla opaco
Lavabo tutto fuori Susina in ceramica nero
Specchiera Tonda Ø 80 cm

L 166 x D 38 cm + protrusion of panels
Pollock lacquered in matt Perla
Top lacquered in matt Perla
Susina overcounter wash basin in black ceramic
Tonda Mirror 80 cm diameter

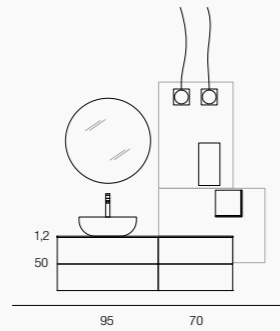

Magnum_03 (pag. 10-11)
L.166 x P.38 cm + sporgenza lastre
Pollock laccato Perla opaco
Top laccato Perla opaco
Lavabo tutto fuori Susina in ceramica nero
Specchiera Tonda Ø 80 cm

L 166 x D 38 cm + protrusion of panels
Pollock lacquered in matt Perla
Top lacquered in matt Perla
Susina overcounter wash basin in black ceramic
Tonda Mirror 80 cm diameter

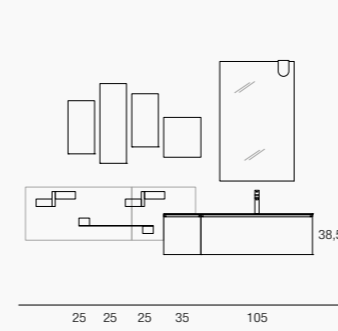

Magnum_05 (pag. 20-21)
L.141 x P.51 cm + sporgenza
lastre e pensili
Laccato opaco Brezza con stampa Lettering
Top in cristallo sabbato Bianco
con lavabo integrato rettangolare
Specchiera AK + faretto Cremino

L 141 x D 51 cm + panels and shelves protrusion
Lacquer in matt Brezza with Lettering print
White etched glass top
with rectangular built-in wash basin
AK mirror + Cremino spotlight

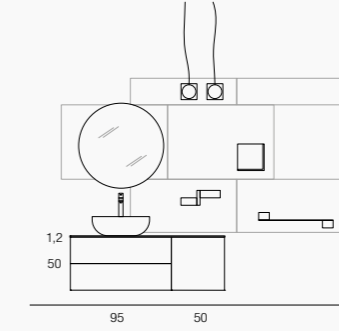

Magnum_06 (pag. 24-25)
L.146 x P.38 cm + sporgenza lastre
Pollock laccato Perla opaco
Top laccato Perla opaco
Lavabo tutto fuori Susina in ceramica nero
Specchiera Tonda Ø 80 cm

L 146 x D 38 cm + protrusion of panels
Pollock lacquered in matt Perla
Top lacquered in matt Perla
Susina overcounter wash basin in black ceramic
Tonda Mirror 80 cm diameter

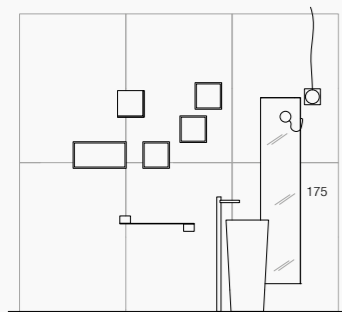

Magnum_01 (pag. 12-13)
L.210 x H.200 cm
Laccato opaco Bianco, The Verde,
Vaniglia, Petrolio
Lavabo freestanding Macho in teknorit
Specchiera AK con faretto

L 210 x H 200 cm
Matt lacquer in White, The Verde,
Vaniglia, Petrolio
Macho free-standing wash basin in teknorit
AK mirror with spotlight

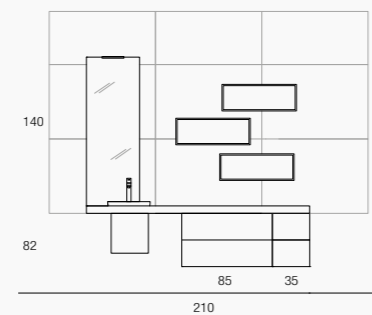

Magnum_04 (pag. 16-17)
L.210 x P.51 cm+ sporgenza lastre
Laccato Germoglio e Bianco opaco
+ stampa decor
Top legno invecchiato sp.8 cm
Lavabo incasso soprapiano Boule
Specchiera AK con faretto Aifon

L 210 x D 51 cm + protrusion of panels
Lacquer in Germoglio and matt White
+ print decor
Top in 8 cm thick aged wood
Built-in counter top Boule wash basin
AK mirror with Aifon spotlight

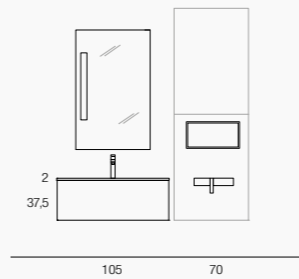

Magnum_07 (pag. 28-29)
L.106 x P.51 cm
Pollock laccato Bianco opaco,
Fiordaliso e The Verde
Top ecomalta Nettuno con lavabo integrato
Specchiera Plane

L 106 x D 51 cm
Pollock lacquered in matt Perla,
Fiordaliso and The Verde
Top in Ecomalta Nettuno with built-in wash basin
Plane mirror

Finiture

Finishes

ROVERE NODATO / KNOTTED OAK



Naturale Riso Orzo



Farro Mais Segale Lenticchia

LACCATO OPACO / MATT LACQUER



Inox Nero Grigio fumo di Londra Cenere Grigio Perla Brezza Bianco



New Pergamon Ecrù Juta Canapa Terranova Brown Cacao



Terra Visone Verde bosco Verde oliva Verde Twiggi The verde Germoglio



Fiordaliso Vaniglia Giallo Polline Arancio Mattone Rosso Fuoco Bordeaux



Rosso India Blu Night Blu Marin Navy Petrolio Cascata Cielo



Acquamarina Nuvola Lavanda Glicine Rosa confetto Lilla light Boccio



Amarena Lampone

thank you

Design: Ufficio Tecnico Arcom
Progetto Grafico: Lokomotiv
Coordinamento al Progetto Grafico: Arcom
Foto: Indoor
Direzione Artistica: Adriani & Rossi Edizioni
Fotolito: Luce
Stampato: Luglio 2015



ARCOM srl

33070 Maron di Brugnera / PN - Italy

Viale Lino Zanussi, 34/B

Tel. +39.0434.613619 / 1573020

Fax +39.0434.608137

e-mail: info@arcombagno.com

www.arcombagno.com



e-mail: gruppoatma@gruppoatma.it

<http://www.gruppoatma.it>